

По вопросам продаж и поддержки обращайтесь:

Архангельск (8182)63-90-72	Краснодар (861)203-40-90	Рязань (4912)46-61-64
Астана (7172)727-132	Красноярск (391)204-63-61	Самара (846)206-03-16
Белгород (4722)40-23-64	Курск (4712)77-13-04	Санкт-Петербург (812)309-46-40
Брянск (4832)59-03-52	Липецк (4742)52-20-81	Саратов (845)249-38-78
Владивосток (423)249-28-31	Магнитогорск (3519)55-03-13	Смоленск (4812)29-41-54
Волгоград (844)278-03-48	Москва (495)268-04-70	Сочи (862)225-72-31
Вологда (8172)26-41-59	Мурманск (8152)59-64-93	Ставрополь (8652)20-65-13
Воронеж (473)204-51-73	Набережные Челны (8552)20-53-41	Тверь (4822)63-31-35
Екатеринбург (343)384-55-89	Нижний Новгород (831)429-08-12	Томск (3822)98-41-53
Иваново (4932)77-34-06	Новокузнецк (3843)20-46-81	Тула (4872)74-02-29
Ижевск (3412)26-03-58	Новосибирск (383)227-86-73	Тюмень (3452)66-21-18
Казань (843)206-01-48	Орел (4862)44-53-42	Ульяновск (8422)24-23-59
Калининград (4012)72-03-81	Оренбург (3532)37-68-04	Уфа (347)229-48-12
Калуга (4842)92-23-67	Пенза (8412)22-31-16	Челябинск (351)202-03-61
Кемерово (3842)65-04-62	Пермь (342)205-81-47	Череповец (8202)49-02-64
Киров (8332)68-02-04	Ростов-на-Дону (863)308-18-15	Ярославль (4852)69-52-93

Единый адрес: beh@nt-rt.ru **Веб-сайт:** www.bhr.nt-rt.ru

**Измерители уровня и температуры Nivovent NV
71 Buhler**

Level and temperature switch with display NV 71D

- Highly visible LED display indicates the switching outputs
- High performance air breather with replaceable element
- Optional air breather clogging indicator
- Up to 4 programmable temperature switching outputs
- Continuous temperature signal (adjustable current or voltage) plus one programmable switching output
- Switching output adjustable as window or hysteresis
- Two switching outputs adjustable as frequency output (1 to 100 Hz)
- Menu structure based on the VDMA guidelines
- Min/Max memory, logbook function



Level and temperature switch NV 71

- Flange according to DIN 24557 Part 2
- High performance air breather with replaceable element
- Optional air breather clogging indicator
- Multiple connector options
- Up to 4 level contacts or 2 switching outputs for level plus RTD or analogue output for temperature
- Reliable dynamic float system
- Probe length up to 1.5 m (longer on request)
- Up to 230 V applicable

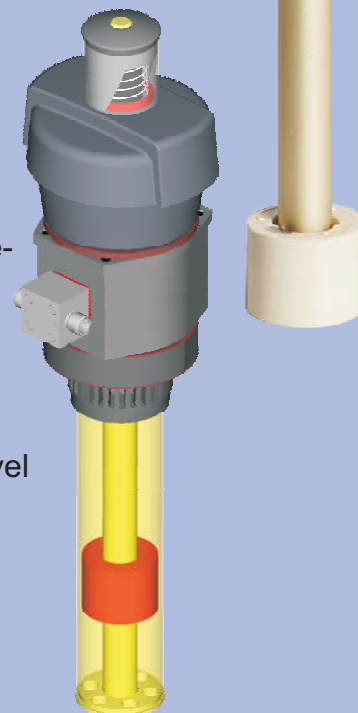

Technical data

NV 71

Basic units

max. operating pressure	1 bar
operating temperature	-20 °C to +80 °C
min. density of fluid	0.80 kg/dm ³ / SK 610 0.85 kg/dm ³ / SK 221
lengths	mm
	280, 370, 500 (standard) variable up to max. 1500

MS VA

weight at L=280 mm	790 g	870 g
approx.	30 g	50 g
add. per 100 mm		

Air breather filter

grade of filtration	HY Type Hydac BF 7
accessories	3 µm filling protection cover - not applicable for filling adapter -

Material / Design

float	MS hard PU SK 610	VA* 1.4571 SK 221
immersion tube	brass	1.4571
flange/ filter housing	PA	PA
SSR (option)	brass	stainless steel

Level contacts

function	K10 NO / NC	W11 change over
max. voltage	230 V	48 V
max. current	0.5 A	0.5 A
max. contact load	10 VA	20 VA
min. contact distance	40 mm	40 mm

NO = normally open / NC = normally closed at empty reservoir

Temperature contact

# of temp. contacts	TK 1	TM 2
max. voltage	230 V	230 V
max. current	2.5 A	2 A
max. contact load	100 VA	100 VA

Function

switching point °C	NC 50/60/70/80	NO 50/60/70/80
tolerance	±3 K	±5 K
max. hysteresis	10 K ±3 K	26/35/40/45 K ±5 K

NC= normally open / NO = normally closed (at low temperature)
other temperatures & designs with 2 x TK contact on request

Temperature sensor

tolerance	Pt 100 class B, DIN EN 60751 ± 0.8 °C
-----------	---

Temperature transmitter

sensor element	KT Pt 100 class B, DIN EN 60751
measurement range	0 °C to +100 °C
operating voltage (U _B)	10-30 V DC
output	4 - 20 mA
load Ω max.	(U _B - 7.5 V) / 0.02 A
other measurement ranges	on request

Options/ Accessories (see details on page 6)

- VS** visual clogging indicator for the air breather
- BFA**** filling adapter incl. ribbed flange with sieve insert:
- SSR**** stilling tube with support ring and filling adapter
- MT** for Multiterminal
- MTS** for Multiterminal including stilling tube
- FCT** Fluidcontrolterminal

* not available in combination with option **FCT**

** not available in combination with option **FCT, MT and MTS**

O P T I O N A L

Flange picture

according to DIN 24557/part 2

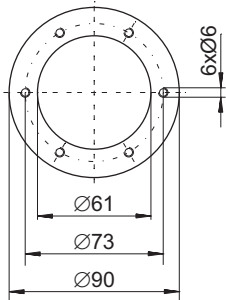

Float SK 610 for NV 71-MS

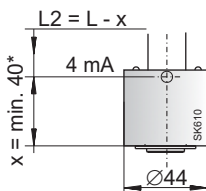

Float SK 221 for NV 71-VA

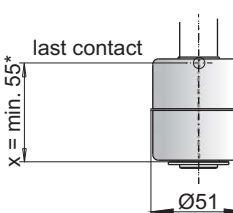

* min. 80 with temperature

Basic version

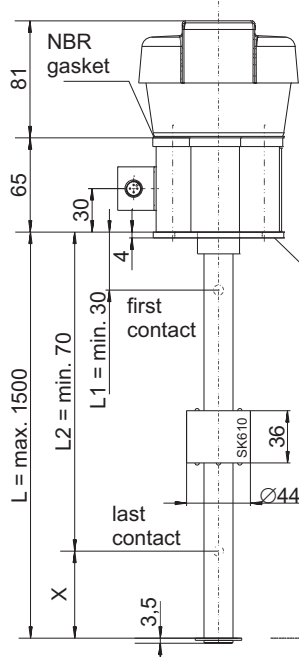

Design with options

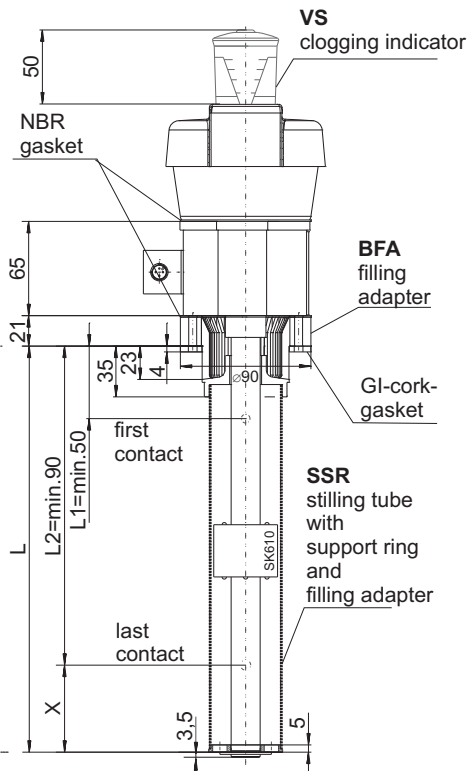

Product code for NV 71

NV 71-HY- **A** **B** **C**

Series

Nivovent NV 71-HY

Design

MS brass

VA* float and immersion tube
stainless steel

Connector

M3

S6

M12

2M12

Lengths (max. 1500 mm)

280

370

500

other lengths (please specify)

level contacts

1-4

Level contact

K = NC/NO

W = change over

* not available in combination with option FCT

** not available in combination with option **FCT, MT and MTS**

***not for combination with temperature contact TM

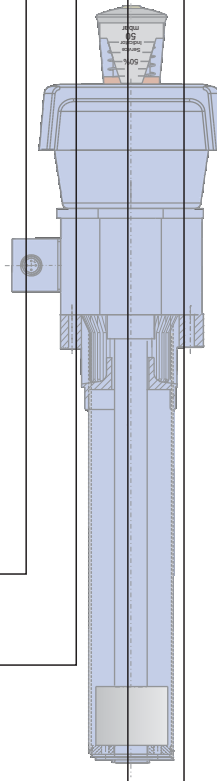

Options / Accessories

VS = clogging indicator

BFA** = filling adapter

SSR** = stilling tube with
filling adapter

MT = for Multiterminal

MTS = for Multiterminal incl.
stilling tube

FCT = Fluidcontrolterminal

Only for double temp. contact

C T2 (2nd Temperature contact)

Opener Closer

TM50NC TM50NO =50°C

TM60NC TM60NO =60°C

TM70NC TM70NO =70°C

TM80NC TM80NO =80°C

B T1 (1st Temperature contact)

NC NO

TM50NC TM50NO =50°C

TM60NC TM60NO =60°C

TM70NC TM70NO =70°C

TM80NC TM80NO =80°C

A Temperature ***

Pt 100 (RTD) = Temperature sensor

KT = Temperature transmitter

TK = Temperature contact

TK50NC = 50°C (NC)

TK60 NC = 60°C (NC)

TK70 NC = 70°C (NC)

TK80 NC = 80°C (NC)

TK50 NO = 50°C (NO)

TK60 NO = 60°C (NO)

TK70 NO = 70°C (NO)

TK80 NO = 80°C (NO)

Accessories

Part-No. 4-pole Description

9144 05 0010 Connecting cable M12x1, 1,5 m, elbow connector (female) and straight connector (male)

9144 05 0046 Connecting cable M12x1, 3,0 m, elbow connector (female) and straight connector (male)

9144 05 0047 Connecting cable M12x1, 5,0 m, elbow connector (female) and wire

Example for order



You need: Level switch brass with air breather and clogging indicator, length L=500 mm, 2 level contacts and temperature contact TK 80 °C as opener, 1st contact: 100 mm NC, 2nd contact: 420 mm NO

You order: NV 71-HY-MS-S6-500-2K -TK80NC-VA, L1=100 NC, L2 = 420 NO

Connector	M3 (DIN43650)	S6 (DIN43651)	M12 (base)	2x M12 (base)
max. voltage	3 pol. + PE 230 VAC/DC*	6 pol. + PE 230 VAC/DC*	4 pol. 30 VDC	4 pol./4 pol. 30 VDC
protection class	IP 65	IP 65	IP67**	IP67**
cable connection	PG 11	M20x1,5		
max. # of contacts	1 x K10 / 1 x TK	3 x K10 / 1 x TK	1 x K10 / 1 x TK	3 x K 10 / 1 x TK
Level / Temp. contact	- / -	2 x K10 / 2 x TM	- / -	2 x K10 / 2 x TM
	- / -	1 x W11 / 1 x TK	- / -	1 x W11 / 1 x TK
		1 x W11 / 2 x TM		1 x W11 / 2 x TM
level only	2 x K10	4 x K10	2 x K10	4 x K10
or	1 x W11	2 x W11	1 x W11	2 x W11

* max. 48V for change over contact / **with casted connector head / other connectors on request

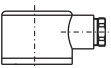
Standard pin assignment NV 71

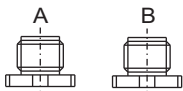
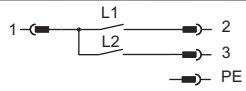
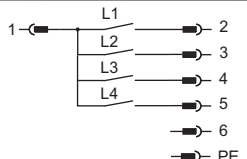
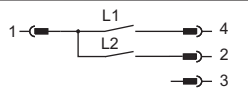
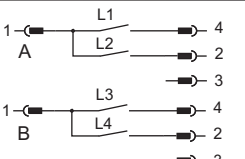
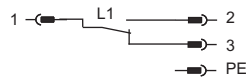
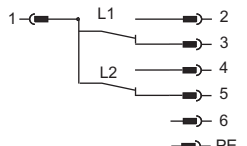
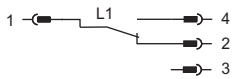
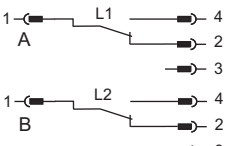
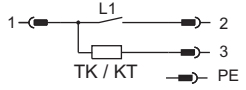
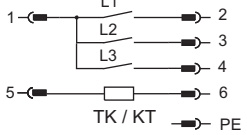
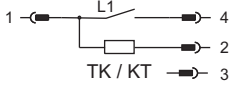
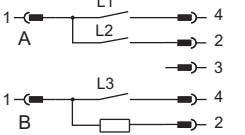
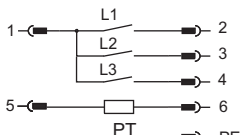
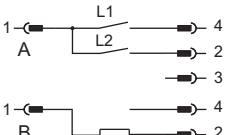
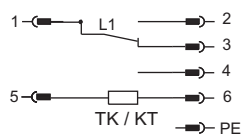
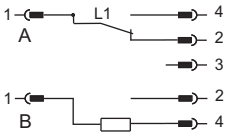
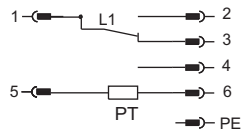
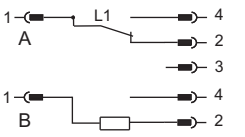
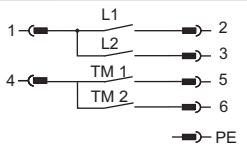
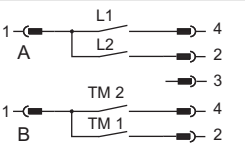
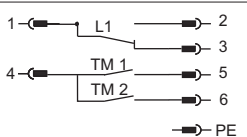
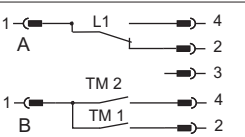
Connector	M3 (DIN EN 175301-803)	S6 (DIN EN 175201-804)	M12 (base)	2 x M12 (base)
			 	
only level contact(s) Type K10				
only level contact(s) Type W11				
level contact(s) Type K10 and temperature				
level contact(s) Type K10 and Pt 100 (RTD)				
level contact(s) Type W11 and temperature				
level contact(s) Type W11 and Pt100 (RTD)				
level contact(s) Type K10 and 2 temp. contacts				
level contact Type W11 and 2 temp. contacts				

TK/TM = Thermo switch KT = temperature transmitter PT = temperature sensor Pt 100 (RTD) other configurations on request

Options / Accessories

- VS** visual clogging indicator for the air breather: analog underpressure indicator, display range 0.35 bar.
- BFA*** filling adapter incl. ribbed flange with sieve insert: this option allows that small oil quantities can be filled via the air breather housing. Therefore the corresponding housing is equipped with that version.
- SSR*** stilling tube with support ring and filling adapter: This includes the option stilling tube as well as the option for filling as the **BFA**. The stilling tube is made of the same material as the requested immersion tube (MS/VA).
- MT** for integration into Multiterminal: The basic unit will be mounted to the Multiterminal. For specification we refer to data sheet DA 10 0201.
- MTS** for integration into Multiterminal including stilling tube: in addition to the basic unit, a stilling tube with support ring is mounted to the Multiterminal.
- FCT** Fluidcontrolterminal: The Fluidcontrolterminal (**FCT**) will be mounted to the basic product. For specification we refer to data sheet DA 10 0202.

* not available in combination with option **FCT**, **MT** and **MTS**

По вопросам продаж и поддержки обращайтесь:

Архангельск (8182)63-90-72	Краснодар (861)203-40-90	Рязань (4912)46-61-64
Астана (7172)727-132	Красноярск (391)204-63-61	Самара (846)206-03-16
Белгород (4722)40-23-64	Курск (4712)77-13-04	Санкт-Петербург (812)309-46-40
Брянск (4832)59-03-52	Липецк (4742)52-20-81	Саратов (845)249-38-78
Владивосток (423)249-28-31	Магнитогорск (3519)55-03-13	Смоленск (4812)29-41-54
Волгоград (844)278-03-48	Москва (495)268-04-70	Сочи (862)225-72-31
Вологда (8172)26-41-59	Мурманск (8152)59-64-93	Ставрополь (8652)20-65-13
Воронеж (473)204-51-73	Набережные Челны (8552)20-53-41	Тверь (4822)63-31-35
Екатеринбург (343)384-55-89	Нижний Новгород (831)429-08-12	Томск (3822)98-41-53
Иваново (4932)77-34-06	Новокузнецк (3843)20-46-81	Тула (4872)74-02-29
Ижевск (3412)26-03-58	Новосибирск (383)227-86-73	Тюмень (3452)66-21-18
Казань (843)206-01-48	Орел (4862)44-53-42	Ульяновск (8422)24-23-59
Калининград (4012)72-03-81	Оренбург (3532)37-68-04	Уфа (347)229-48-12
Калуга (4842)92-23-67	Пенза (8412)22-31-16	Челябинск (351)202-03-61
Кемерово (3842)65-04-62	Пермь (342)205-81-47	Череповец (8202)49-02-64
Киров (8332)68-02-04	Ростов-на-Дону (863)308-18-15	Ярославль (4852)69-52-93

Единый адрес: beh@nt-rt.ru **Веб-сайт:** www.bhr.nt-rt.ru