

По вопросам продаж и поддержки обращайтесь:

Архангельск (8182)63-90-72	Краснодар (861)203-40-90	Рязань (4912)46-61-64
Астана (7172)727-132	Красноярск (391)204-63-61	Самара (846)206-03-16
Белгород (4722)40-23-64	Курск (4712)77-13-04	Санкт-Петербург (812)309-46-40
Брянск (4832)59-03-52	Липецк (4742)52-20-81	Саратов (845)249-38-78
Владивосток (423)249-28-31	Магнитогорск (3519)55-03-13	Смоленск (4812)29-41-54
Волгоград (844)278-03-48	Москва (495)268-04-70	Сочи (862)225-72-31
Вологда (8172)26-41-59	Мурманск (8152)59-64-93	Ставрополь (8652)20-65-13
Воронеж (473)204-51-73	Набережные Челны (8552)20-53-41	Тверь (4822)63-31-35
Екатеринбург (343)384-55-89	Нижний Новгород (831)429-08-12	Томск (3822)98-41-53
Иваново (4932)77-34-06	Новокузнецк (3843)20-46-81	Тула (4872)74-02-29
Ижевск (3412)26-03-58	Новосибирск (383)227-86-73	Тюмень (3452)66-21-18
Казань (843)206-01-48	Орел (4862)44-53-42	Ульяновск (8422)24-23-59
Калининград (4012)72-03-81	Оренбург (3532)37-68-04	Уфа (347)229-48-12
Калуга (4842)92-23-67	Пенза (8412)22-31-16	Челябинск (351)202-03-61
Кемерово (3842)65-04-62	Пермь (342)205-81-47	Череповец (8202)49-02-64
Киров (8332)68-02-04	Ростов-на-Дону (863)308-18-15	Ярославль (4852)69-52-93

Единый адрес: beh@nt-rt.ru **Веб-сайт:** www.bhr.nt-rt.ru

Измерители уровня и температуры Nivovent NV 73 Buhler

Level or level and temperature sensor NV 73

- Flange according to DIN 24557 / Part 2
- High performance air breather with replaceable element
- Optional air breather clogging indicator
- Continuous level measurement
- Continuous level and temperature measurement
- 4-20 mA outputs (2-10 V on request)
- Resolution 5 mm (level)
- Various connector options
- Reliable dynamic float system
- Optional float and probe in stainless steel optional
- Probe length up to 1420 mm (longer on request)



Technical data

NV 73

Basic units

K = continuous level and temperature measurement
KN = continuous level measurement

max. operating pressure 1 bar
 operating temperature -20 °C to 80 °C
 min. density of fluid 0.80 kg/dm³ / SK 604
 0.85 kg/dm³ / SK 221
 Lengths (L=) mm 280, 370, 500, 670, 820, 970
 1120, 1270, 1420
 (other lengths on request)

weight **MS** **VA**
 at L=280mm, approx. 800 g approx. 900 g
 plus per 100 mm approx. 30 g approx. 50 g

Air breather filter HY Type Hydac BF 7
 grade of filtration 3 µm
 Accessories filling protective cover
 - not applicable for filling adapter -

Material / Design **MS** **VA***
 float hard PU 1.4571
 SK 604 SK 221
 immersion tube brass 1.4571
 flange / filter housing PA PA
 stilling tube (option) brass stainless steel

Level measurement

measuring resistor reed contact
 resolution 5 mm
 supply voltage (U_B) 10 - 30 V
 ripple < 1 %
 output signal 4-20 mA
 max. load Ω =(U_B - 7.5 V) / 0.02 A

Temperature measurement at Type 73 K

measuring resistor Pt 100 (RTD)
 class B DIN EN 60 751
 tolerance ± 0.8 °C
 supply voltage (U_B) 10 - 30 V
 ripple < 1 %
 output signal 4-20 mA
 (≈ 0 to 100 °C)
 other ranges on request
 max. load Ω =(U_B - 7.5 V) / 0.02 A

included in the delivery

mounting bolts M5 (6 pieces) and GI -cork gasket
 * not available in combination with option FCT

Flange picture

according to DIN 24557 / Part 2

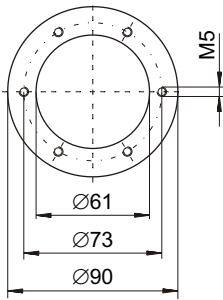

Float SK 604 for NV 73-MS

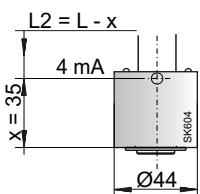

Float SK 221 for NV 73-VA

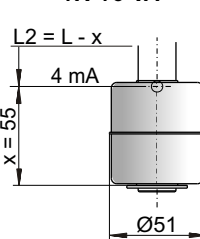

Basic version

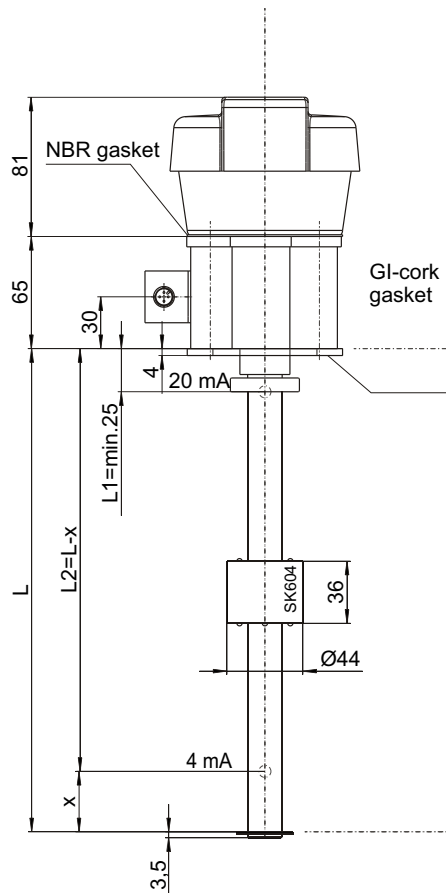

Design with options

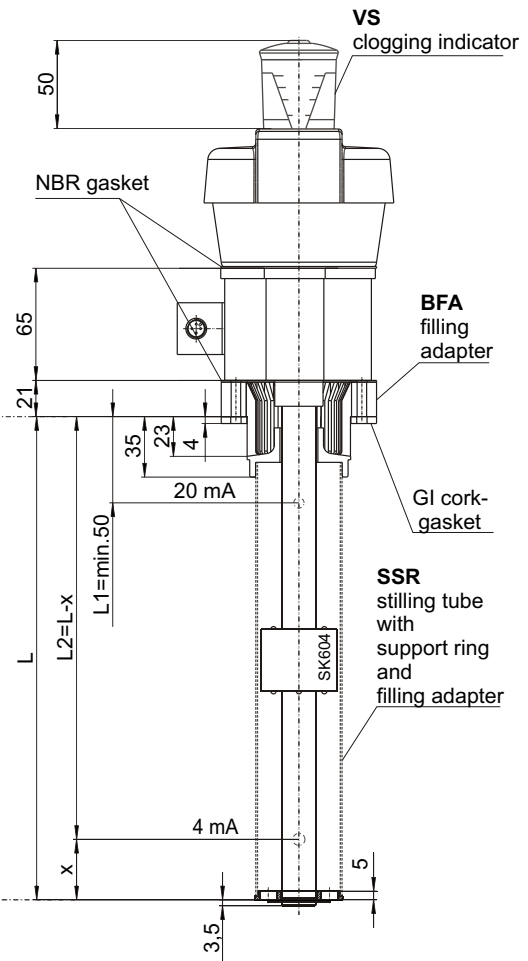

Options / Accessories

- VS** visual clogging indicator for the air breather: analog underpressure indicator, display range 0.35 bar.
- BFA*** filling adapter incl. ribbed flange with sieve insert: this option allows that small oil quantities can be filled via the air breather housing. Therefore the corresponding housing is equipped with that version.
- SSR*** stilling tube with support ring and filling adapter: This includes the option stilling tube as well as the option for filling as the **BFA**. The stilling tube is made of the same material as the requested immersion tube (brass / stainless steel).
- MT** for integration into Multiterminal: The basic unit will be mounted to the Multiterminal. For specification we refer to data sheet DE 10 0201.
- MTS** for integration into Multiterminal including stilling tube: in addition to the basic unit, a stilling tube with support ring is mounted to the Multiterminal.
- FCT** Fluidcontrolterminal: The Fluidcontrolterminal (**FCT**) will be mounted to the basic product. For specification we refer to data sheet DE 10 0202.

Optionally, a programmable display and control unit is available which can show and monitor the measurement, see data sheet DE 18 0201.

* not available in combination with option **FCT** and **MT/MTS**

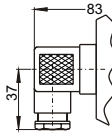
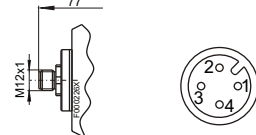
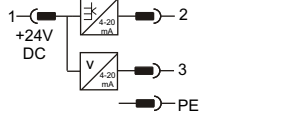
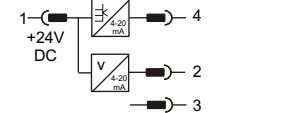
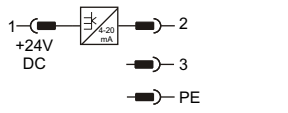
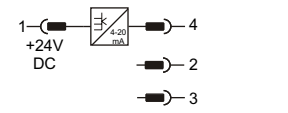
Connector protection system cable connection	M3 (DIN EN 175301-803) 3 pol. + PE IP 65 PG 11	M12 (base) 4 pol. IP67** **with casted connector head
Standard pin assignment		
K continuous level and temperature measurement		
KN continuous level measurement		

Product code for NV 73

NV 73-HY-

Series

Nivovent **NV 73-HY**

K = Level and temperature measurement
KN = only level measurement

Design

MS brass
VA* float and immersion tube stainless steel

Connector

M3
M12

Length (max. 1420 mm)

280 mm
 370 mm
 500 mm
 670 mm
 820 mm
 970 mm
 1120 mm
 1270 mm
 1420 mm

Options / Accessories

BFA** = filling adapter
SSR** = stilling tube with filling adapter
MT = for Multiterminal
MTS = for Multiterminal incl. stilling tube
FCT = Fluidcontrolterminal

VS = clogging indicator

* not available in combination with option FCT

** not available in combination with option FCT, MT and MTS

Accessories:

Part No.	Description
91 44 05 0010	Connecting cable M12x1, 4-pol., 1,5 m, elbow connector (female) and straight connector (male)
91 44 05 0046	Connecting cable M12x1, 4-pol., 3,0 m, elbow connector (female) and straight connector (male)
91 44 05 0047	Connecting cable M12x1, 4-pol., 5,0 m, elbow connector (female) and wire

Furthermore a programmable display and control unit is available which can show and monitor the measurement, see data sheet DE 18 0201.

Example for order

You need: Level and temperature measurement with air breather, resolution 5 mm, brass design with M12 connector and a length L = 670 mm

You order: NV 73-HY-K-MS-M12 / 670

По вопросам продаж и поддержки обращайтесь:

Архангельск (8182)63-90-72	Краснодар (861)203-40-90	Рязань (4912)46-61-64
Астана (7172)727-132	Красноярск (391)204-63-61	Самара (846)206-03-16
Белгород (4722)40-23-64	Курск (4712)77-13-04	Санкт-Петербург (812)309-46-40
Брянск (4832)59-03-52	Липецк (4742)52-20-81	Саратов (845)249-38-78
Владивосток (423)249-28-31	Магнитогорск (3519)55-03-13	Смоленск (4812)29-41-54
Волгоград (844)278-03-48	Москва (495)268-04-70	Сочи (862)225-72-31
Вологда (8172)26-41-59	Мурманск (8152)59-64-93	Ставрополь (8652)20-65-13
Воронеж (473)204-51-73	Набережные Челны (8552)20-53-41	Тверь (4822)63-31-35
Екатеринбург (343)384-55-89	Нижний Новгород (831)429-08-12	Томск (3822)98-41-53
Иваново (4932)77-34-06	Новокузнецк (3843)20-46-81	Тула (4872)74-02-29
Ижевск (3412)26-03-58	Новосибирск (383)227-86-73	Тюмень (3452)66-21-18
Казань (843)206-01-48	Орел (4862)44-53-42	Ульяновск (8422)24-23-59
Калининград (4012)72-03-81	Оренбург (3532)37-68-04	Уфа (347)229-48-12
Калуга (4842)92-23-67	Пенза (8412)22-31-16	Челябинск (351)202-03-61
Кемерово (3842)65-04-62	Пермь (342)205-81-47	Череповец (8202)49-02-64
Киров (8332)68-02-04	Ростов-на-Дону (863)308-18-15	Ярославль (4852)69-52-93

Единый адрес: beh@nt-rt.ru **Веб-сайт:** www.bhr.nt-rt.ru